

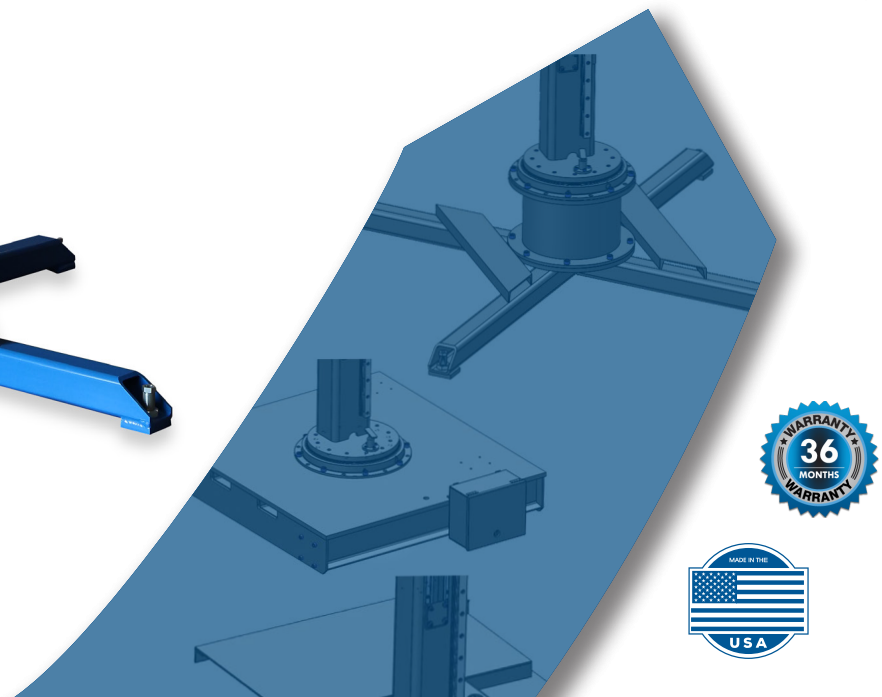

Positioning Solutions since 1972

Whitetail *200 Series Manipulator*

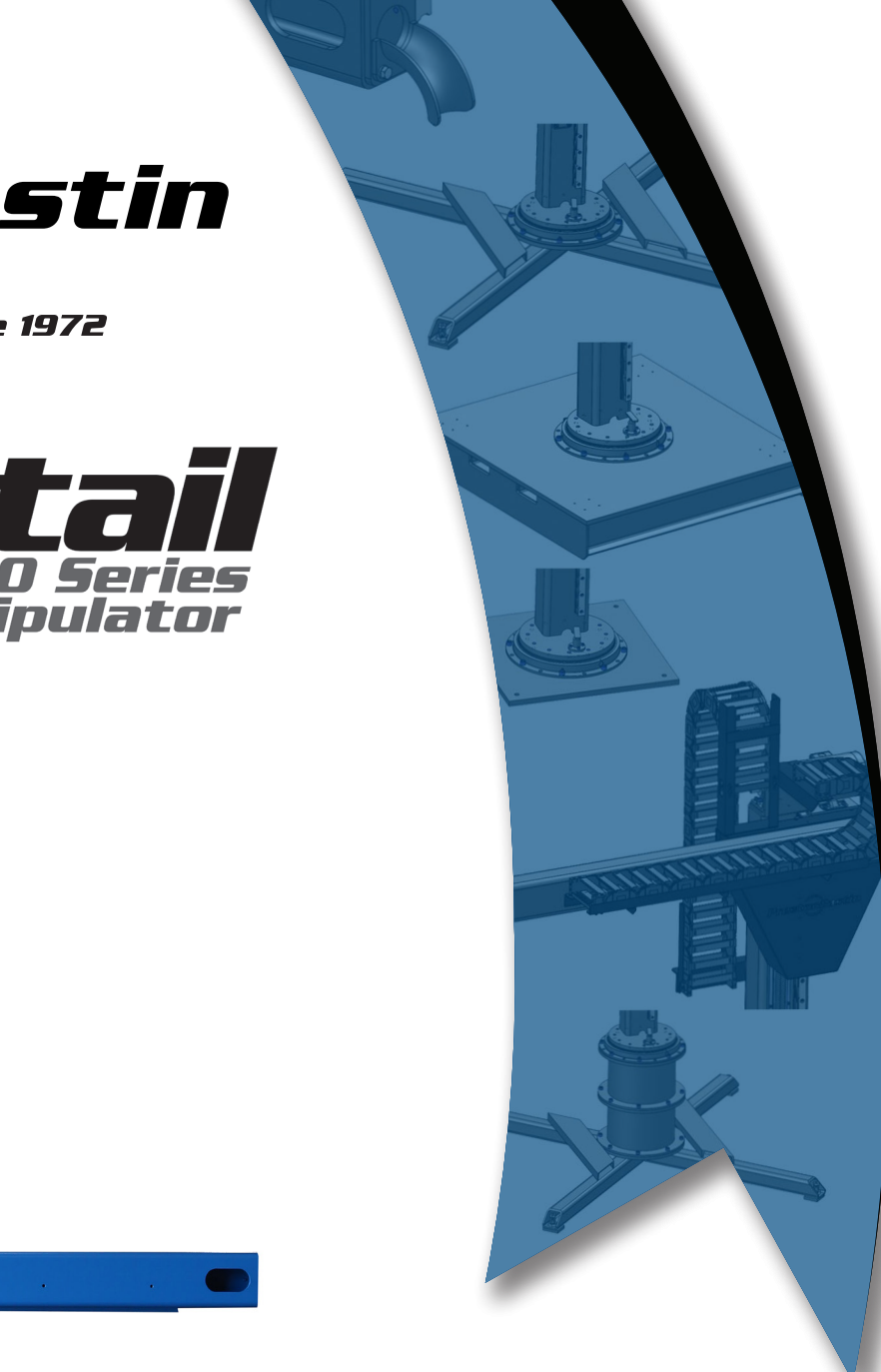

Whitetail

200 Series Manipulator

Features & Benefits

- **Leveling Bolt** – Allows precise leveling of unit with X-Base
- **Simplified Single Plate Saddle Design**
Allows for open surfaces on top and front of ram for mounting of fixed equipment.
- **Predrilled Weld Head Mounting Bracket**
Easily bolts on to adaptors based on your weld head without additional drilling.
- **Linear Rail/Bearing Guideways (One Rail Per Axis)** – Simplifies installation.
- **Enclosure Mounted to Mast**
Simplified access limiting vertical movement on boom
- **Helical Rack/Pinion on Ram/Boom**
Quiet and smooth running. Allows more precise adjustments
- **Cable Cutouts in Front Face of Ram/Boom**
Allows for routing of cables with equipment mounted to end of ram
- **Machine Screw Jack Lift Mechanism**
Increases safety because load is in constant tension

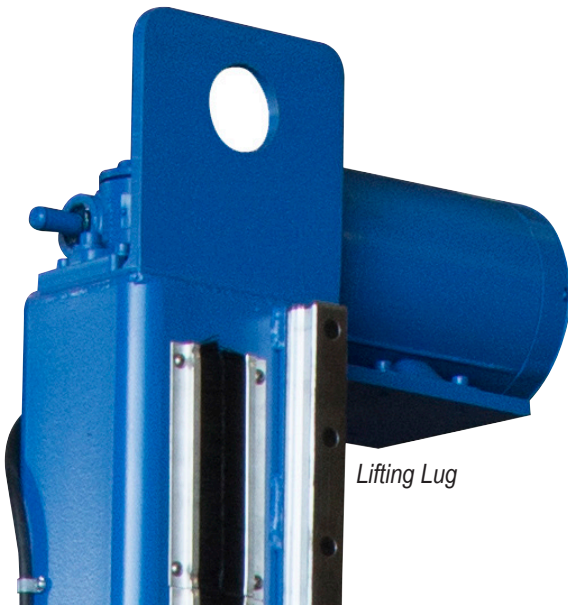
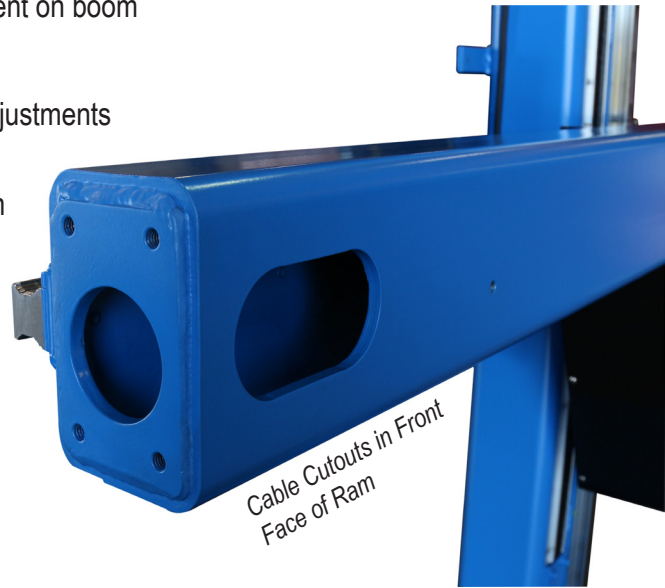
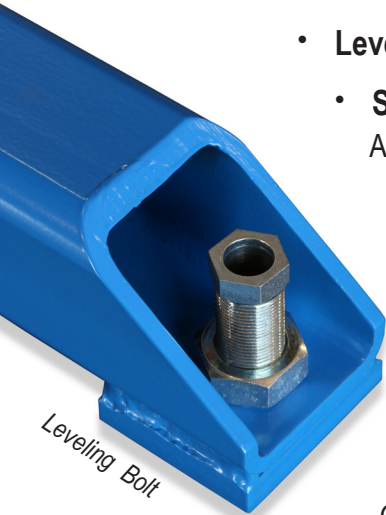

- **Fork Pockets on X-Base and Lifting Lug**
Allows unit to be moved by forklift or crane.
- **Motor Limit Switch** – Prevents damage to unit.

- **Assembled Height**
Six foot unit has a low profile mast for shipping in up right position. 8x8 ships disassembled.
- **Rotational Bearing Ring**
Simplifies assembly versus previous spindle design

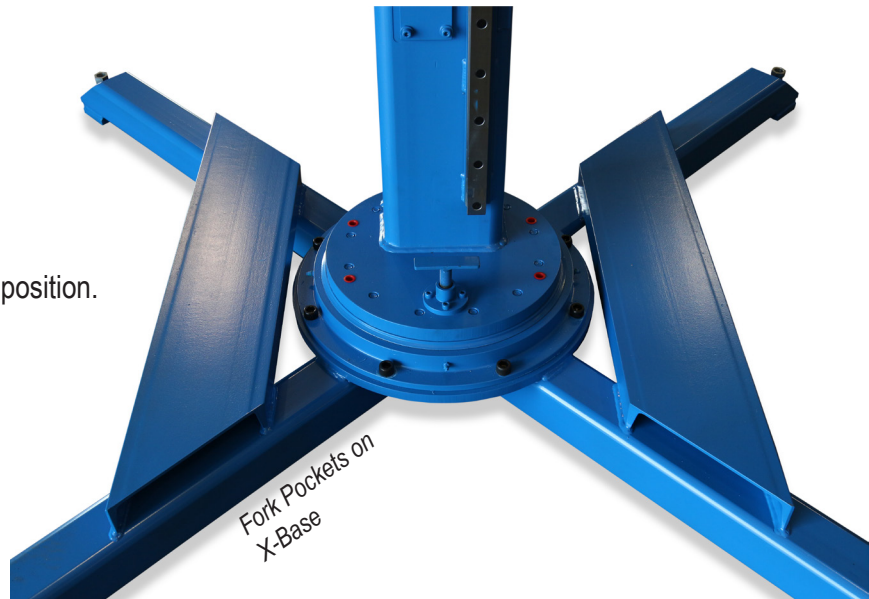

PrestonEastin offers four base options to meet your application need

Options

Anchor Plate

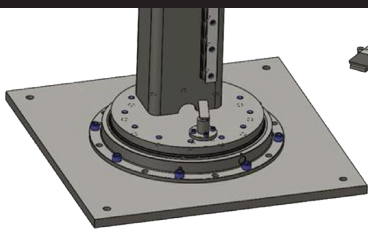

Cost effective solution; The 30"x30" flat plate with anchor holes for installing manipulator in a fixed location. Smaller footprint than the x-base, but **MUST BE ANCHORED TO THE FLOOR.**

X-Base

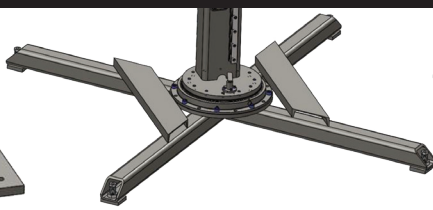

Freestanding base option; includes leveling bolts w/thru holes for anchors. Anchoring is recommended. Includes fork lift pockets for ease of positioning.

Manual Travel Car

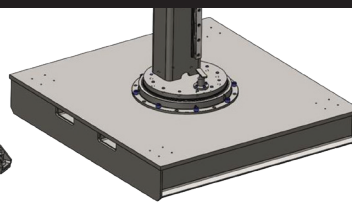

Travels along one axis, forward and back. Will work unguided on a flat concrete floor, or guided on a 39" C/L v-groove track. Includes fork lift pockets for ease of positioning.

Powered Travel Car

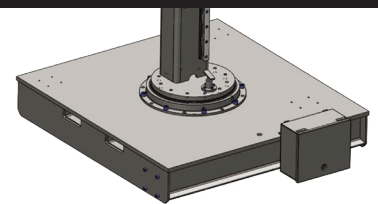

Travels along one axis, forward and back. Will work unguided on a flat concrete floor, or guided on a 39" C/L v-groove track. Includes fork lift pockets for ease of positioning. 120v 1ph AC powered with hand pendant control.

ACCESSORIES

Cable Carrier Set

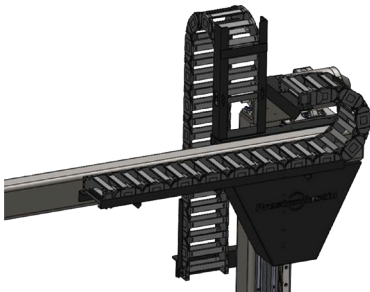

For cable installation; includes brackets and cable carriers for mast and ram; Cable opening 1.6" x 6.6".

Cable Strain Relief

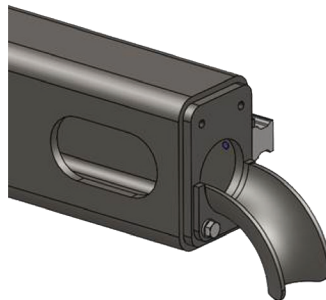

For supporting cables installed through the end of the ram; can be mounted to Whitetail MA200 Series and Medium Duty Manipulators.

Power Supply Shelf

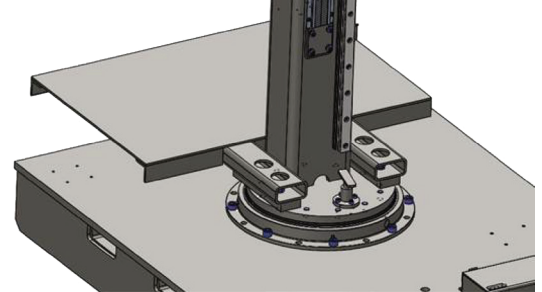

For mounting of welding power supply; 36"x24" platform; Rotates with manipulator.

12-Inch Riser



Installs between manipulator rotational bearing ring and any of the four base options; Adds 12" of overall height to the manipulator; Can be stacked two high (maximum 24" height addition).

SPECIFICATIONS

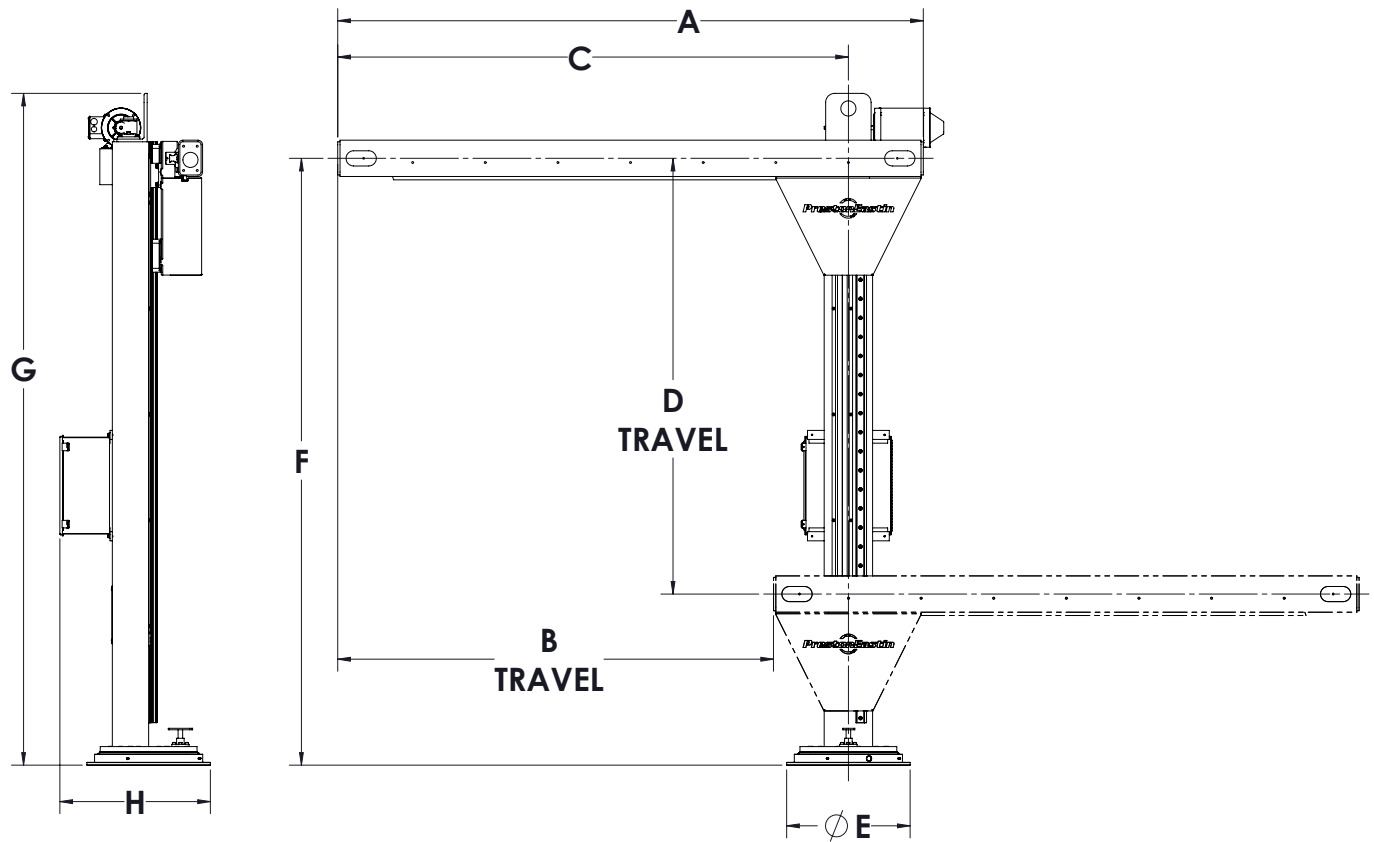

MA200 Dimensions

Model	Size	A	B	C	D	E	F	G	H
MA200-66	6 x 6	96.75 in.	6 ft.	84.4 in.	6 ft.	20.4 in.	100.3 in.	111 in.	25 in.
MA200-88	8 x 8	120.75 in.	8 ft.	108.4 in.	8 ft.	20.4 in.	124.3 in.	135 in.	25 in.

Note: Dimensions shown do not include height of optional bases.

Standard Specifications:

Rating: 200 lbs on either or both ends

Lift Motor: ½ HP Inverter-Duty AC Motor

Ram Motor: 1/6 HP Inverter-Duty AC Gearmotor

Mast: Up-Off-Down

Base Rotation: Manual with Swivel Lock

Ram: Forward-Off-Reverse (Variable Speed)

Horizontal Ram Speed: 6-118 inches per minute

Vertical Mast Speed: 36 inches per minute

Hand held pendant

Input Voltage: 115V

Standard Base Options:

Anchor Plate – This is a cost effective flat anchor plate for installing manipulator in a fixed location; Footprint is smaller than the x-base, but **MUST BE ANCHORED TO THE FLOOR**

X-Base – Freestanding base includes leveling bolts w/thru holes for anchors. Anchoring is recommended. Includes fork lift pockets and lifting lug for ease of positioning

Manual Travel Car – Will work unguided on a flat concrete floor, or guided on a v-groove track. Includes fork lift pockets for ease of positioning

Powered Travel Car– Travels along one axis, forward and back. Will work unguided on a flat concrete floor, or guided on a v-groove track. Includes fork lift pockets and lifting lug for ease of positioning. Powered Travel Car 120v 1ph AC powered with hand pendant, Variable speed; 3-60 inches per minute.

Available Options:

Cable Carrier Set – For installation of supply cables; Includes brackets and cable carriers for mast and ram; Cable opening 1.6" x 6.6"

Cable Strain Relief – For supporting supply cables installed through the end of the ram/boom

12" Riser – Installs between manipulator swivel bearing and any of the four base options; Adds 12" of overall height to the manipulator; Can be stacked two high (maximum 24" height addition)

Power Supply Shelf – For mounting customer welding power supply; Attaches above swivel bearing and rotates with mast



9490 North Ridgeway Street
Tulsa, OK 74131

sales@prestoneastin.com
prestoneastin.com

(918) 834-5591
Fax (918) 834-5595